











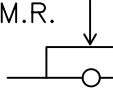
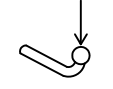



SEAT/VW		Nº de homologación Official approval number Prüfung Nr.
IBIZA-CORDOBA /POLO		Nº d'homologation Número de homologação
	EE0140	e9*94/20*94/20* 2819*00
	EE1140	e9*94/20*94/20* 2820*00

M.M.R. 	S 	D 
1200 kg.	75 kg.	6.96 kN

Par de apriete para los tornillos Tightening torque for bolts Schrauben Drehmoment Couple de serrage pour vis Par de apertado para os parafusos						
M	6	8	10	12	14	16
Nm	10	25	55	85	135	200

Enganche homologado según Directiva 94/20 CE.
Hitch officially approved in accordance with Directive 94/20 CE.
Geprüfte Kupplung gemäß Kennzeichen 94/20 CE.
Crochet homologué selon la Directive 94/20 CE.
Enganche homologado segundo directiva 94/20 CE.

ELEMENTOS DE UNIÓN / CONNECTION COMPONENTS
DAZUGEHÖRENDEN TEILEN / ÉLÉMENTS DE RACCORD
ELEMENTOS DE UNIÃO.

BOLA / BALL / KUGEL BOULE/ BOLA DE REBOQUE	VEHÍCULO / VEHICLE FAHRZEUG / VÉHICULE / VEÍCULO
	
a  2 x M12x65 DIN 931 8.8	c  4 x M10x40 DIN933 8.8
b  2 x M12 DIN 985 8	d  2 x M10 DIN985 8
	e  6 x M10 DIN9021 -
a  4 x M12x25 DIN 933 8.8	f  2 x M10 DIN127 -
b  4 x M12 DIN 125 -	④  2 x TUERCA ESPECIAL -

Este documento debe ser presentado en la I.T.V. junto con el certificado de montaje.
HNOS.SÁNCHEZ-LAFUENTE,S.A. no asume ningún tipo de responsabilidad por daños causados por usos inadecuados.

EE0140
e9*94/20*94/20* 2819*00

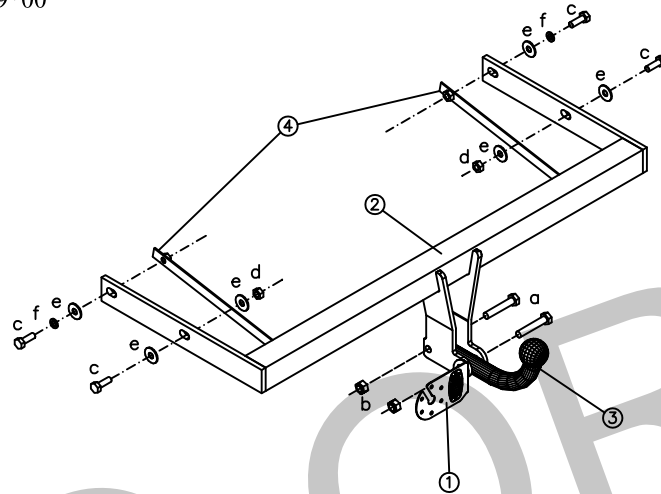

EE1140
e9*94/20*94/20* 2820*00

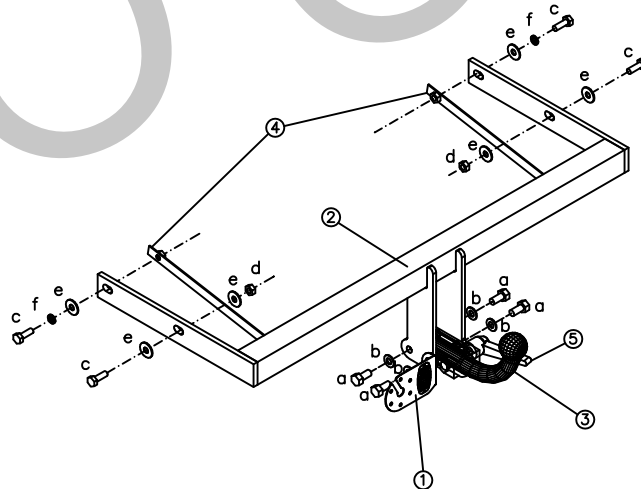



SEAT CORDOBA VW POLO SEAT IBIZA



EE0140



EE1140

Instrucciones de montaje - Installation instructions - Notice de montage - Montage- og driftsvejledning

1

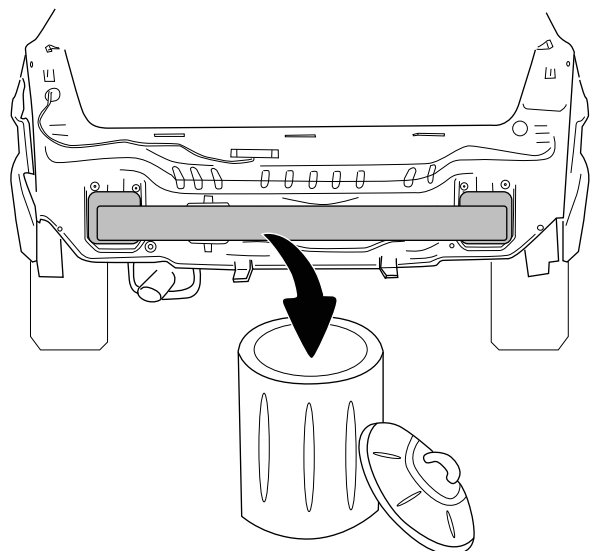
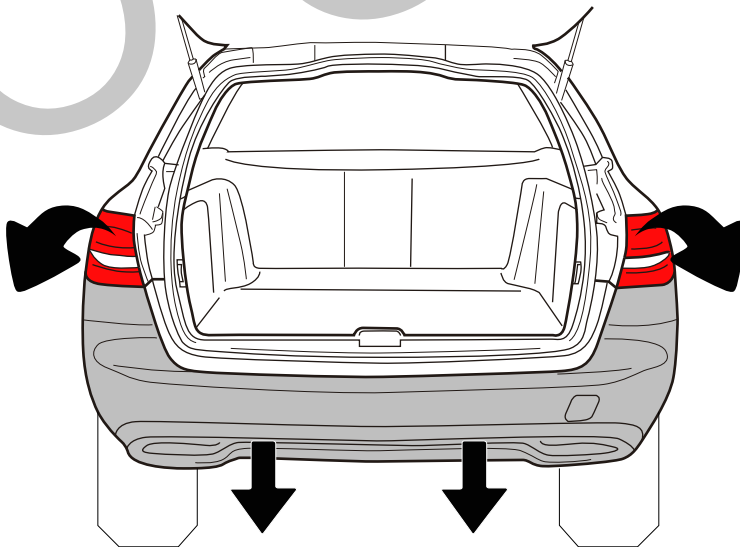

2

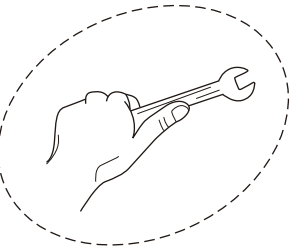
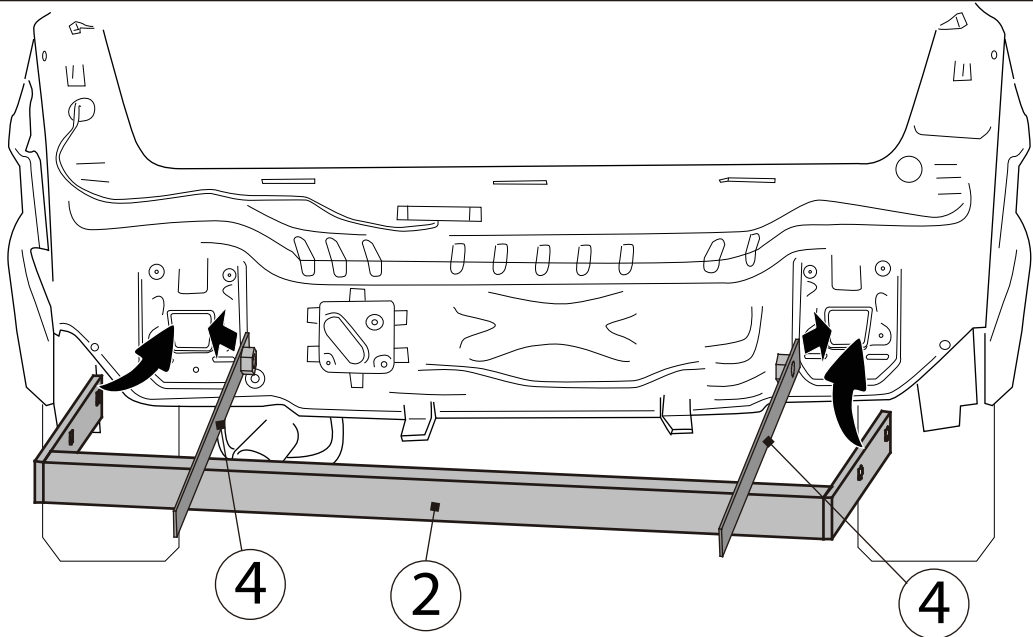
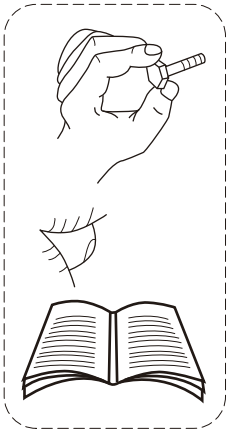

	M6	M8	M10	M12	M14	M16
8.8	10,4Nm	25,0Nm	51,0Nm	87,0Nm	140,0Nm	215,0Nm
10.9	15,5Nm	37,0Nm	75,0Nm	130,0Nm	205,0Nm	310,0Nm
12.9	18,0Nm	43,0Nm	87,0Nm	150,0Nm	240,0Nm	370,0Nm

3

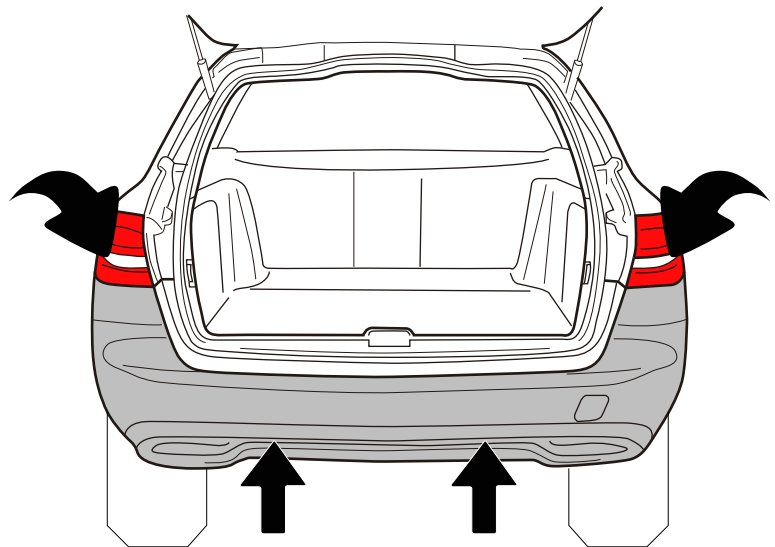
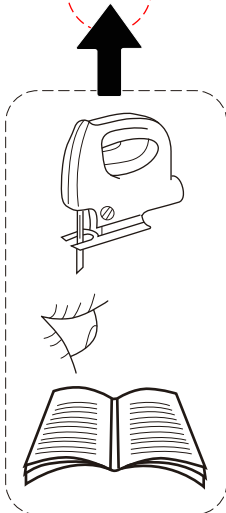
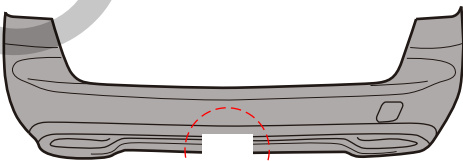

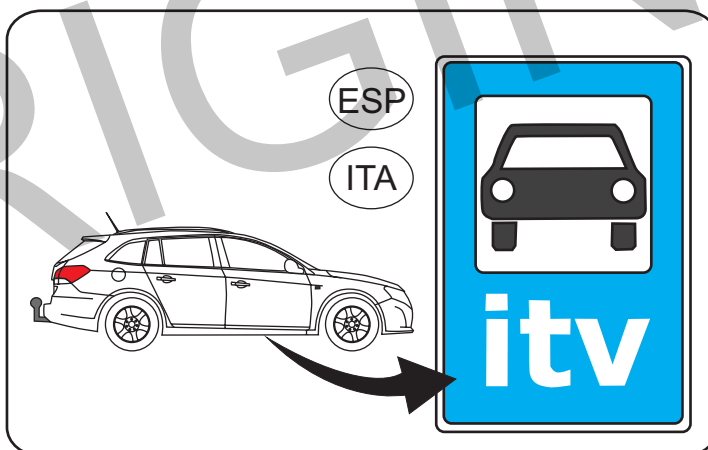
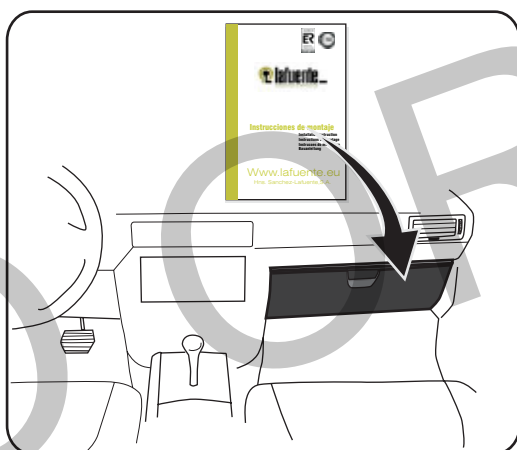
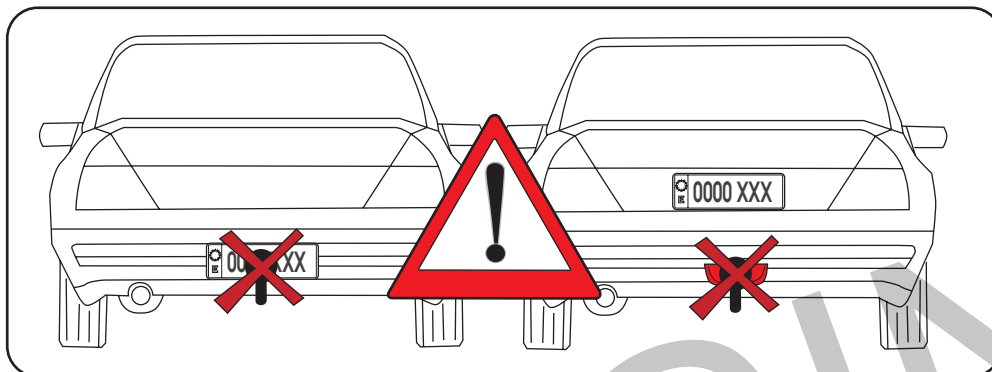
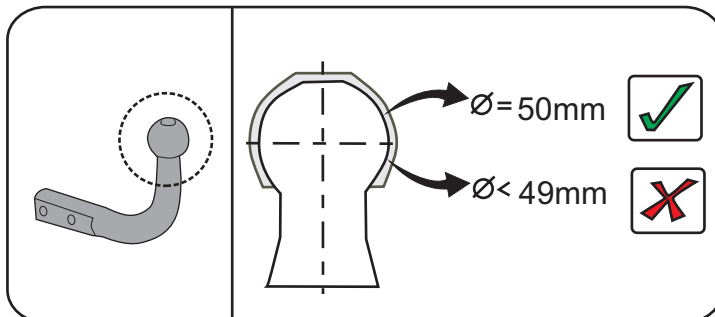
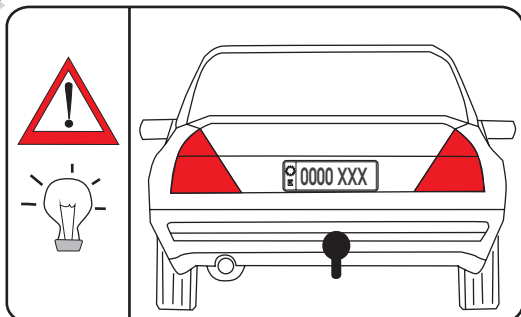
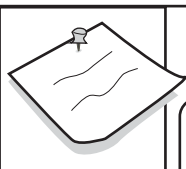

	M6	M8	M10	M12	M14	M16
8.8	10,4Nm	25,0Nm	51,0Nm	87,0Nm	140,0Nm	215,0Nm
10.9	15,5Nm	37,0Nm	75,0Nm	130,0Nm	205,0Nm	310,0Nm
12.9	18,0Nm	43,0Nm	87,0Nm	150,0Nm	240,0Nm	370,0Nm

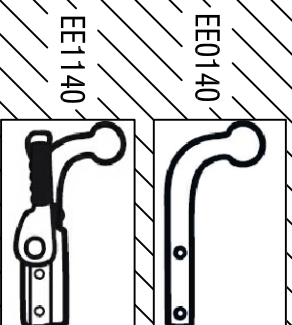
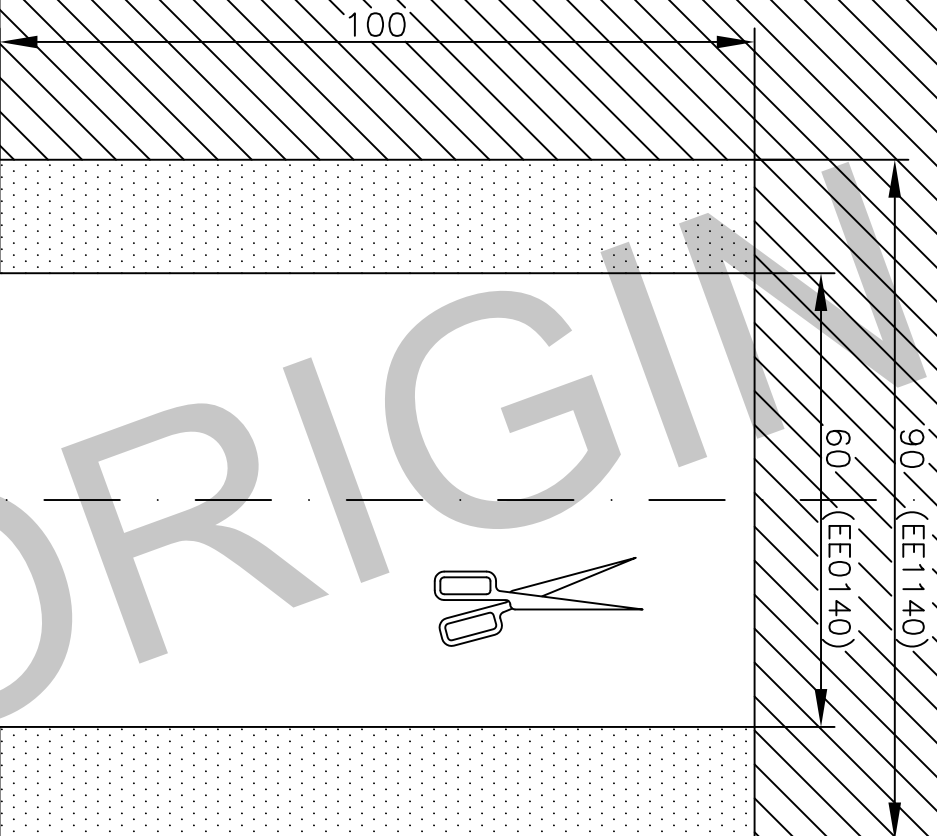

LINEA CENTRAL DEL PARAGOLPES

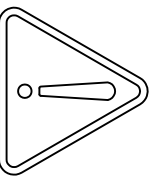

ESP: El corte es orientativo
UK: The cut is indicative

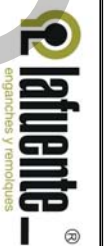

Dibujo:

CORTE PARAGOLPES
SEAT IBIZA / CORDOBA

Escala:
1:1
UNIDADES EN
mm

EE0140-EE1140

Rev.
P1



LINEA CENTRAL
DEL PARAGOLPES

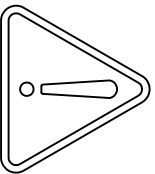
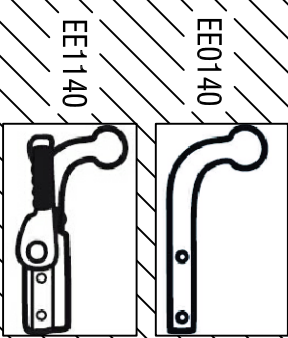
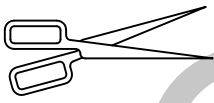
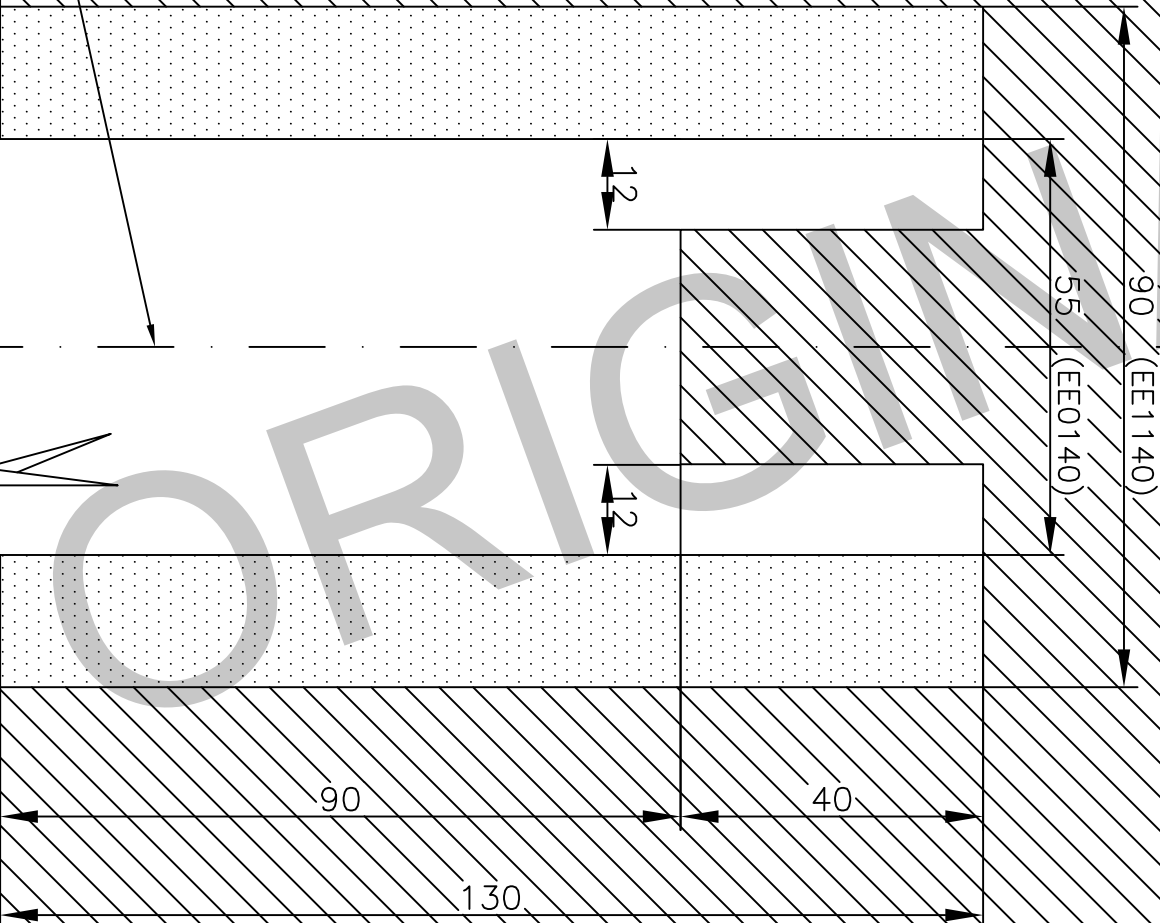

ESP: El corte es orientativo
UK: The cut is indicative



Dibujo: CORTE PARAGOLPES
VW POLO

Escala: 1:1
UNIDADES EN mm

EE0140-EE1140

Rev. P1